

## Strip-free Power Installation Kit

### For Splice Connections

**Note:** Before performing this installation, consider that the enclosure and terminal block are manufactured from plastic materials and are at risk of breaking down in aggressive soil.

This can be solved by making the termination inside an insulation kit, under the end cap or above ground in a non-aggressive environment.

1. Sequentially push the clamping nut,

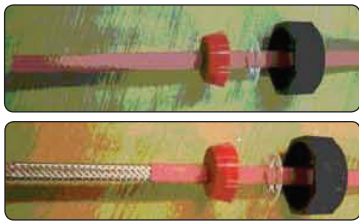

Figure 1

cable stopper and the red seal onto one end of the cable. Ensure the cable end is cut straight. Leave the seal 120mm (4.7") from the cut end.

2. Remove 80mm (3.2") of outer jacket from the cut end, and push the braiding wires back. To secure the ground connection, wrap aluminum tape

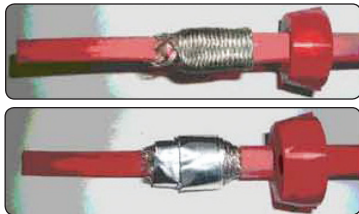

Figure 2

around braiding wires in order to make it a minimum 6.5mm (0.25") long. Position the red seal 90mm (3.5") from the end of the cable.

3. Insert the stripped cable into the strip-free terminal.



Figure 3a

**Note:** Observe the cable passing into the jaws of the cutting blades in **Figure 3b**.

The braiding wires should be in close contact with the metallic ground frame at the point of entry into the strip-free connector.

The following illustration provides an example of how straight and deep the cable should insert into the terminal block. When inserting the cable, ensure the terminal set remains in the enclosure.

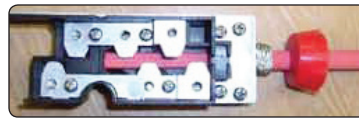

Figure 3b

4. Fasten the seal and clamping nut onto the strip-free connector (hold the cable in place prior to fastening the screws).

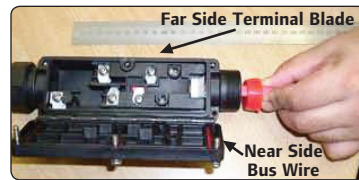

Figure 4

Ensure the far side terminal blade doesn't touch the near side bus wire.

5. Tighten the terminal screws until the cutting blades touch the wires with a minimum torque of 2.5Nm (1.84 lbf-ft).



Figure 5

6. Check for connection by verifying a circuit is present with a conventional multimeter. Once a circuit is verified, close the lid and tighten all the screws to securely waterproof.



Figure 6

### For Power Terminations

1. Slide gland and seal over cable, strip back 80mm (3.2") of jacket and push into strip-free unit.

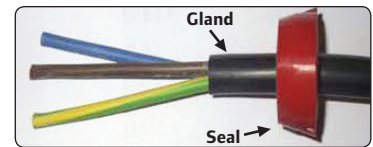

Figure 7

2. Complete electrical connection by securing terminals with screws as shown in **Figure 8**.

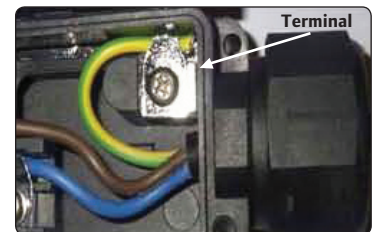
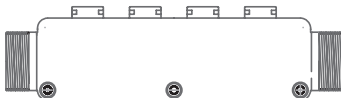
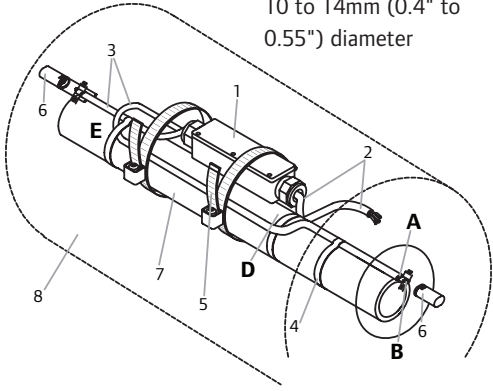

Figure 8

**Warning:** Select a power cable suitable for temperatures in which the equipment is used.

### Typical Assembly Illustration

1. Strip-free Termination Kit (SF-P)
2. Three-layer core flexible power cord, 10 to 14mm (0.4" to 0.55") diameter
3. Braided and jacketed self-regulating heater
4. Fixing tape for heater
5. Fixing strap for strip-free enclosure
6. End seal (SF-E)
7. Pipe
8. Thermal insulation and cladding



### Part List for Strip-free Power Kit

Kit Contents	Single
Termination Kit Body	1
Seal for Flat Heater	1
Seal for Power Cord	1
Lock Nut	2
Cable Stopper	1
Aluminum Tape	1

### Important Notes

- A** • Trim all braids to permit 10mm (0.39") distance from the exposed heating core of the cable.
  - B** • Never connect the bus wires together.
  - C** • Place strip-free outside thermal insulation if pipe temperature exceeds 60°C (140°F).
  - D** • Strap the power cable with fixing tape only.
  - E** • Strap the heater with fixing tape only.
    - If the pipe temperature exceeds 60°C (140°F), lift the strip-free unit off the pipe and then insulate.
    - Ensure the conductor size of power cable is not larger than the bus wire diameter.
    - Ensure the conductor size of ground wire is the same as the power cables.
    - EEx e II T4 Ta = -40°C to 50°C (-40°F to 122°F) Maximum voltage 275 VAC, maximum current per terminal 16 Amps.
    - Inspect equipment regularly, and clean any dust deposits with a damp cloth.
    - Recommended 8Nm (5.9 lbf-ft) for gland nut and minimum 2.5Nm (1.8 lbf-ft) for terminal.
    - Use only stranded conductor for power cable.
    - Clamping nut requires 8Nm (5.9 lbf-ft) of tightening torque to prevent the cables from slipping from the intended location.
    - Terminal requires 2.5Nm (1.8 lbf-ft) of tightening torque to proper contact with the heating cable conductors.
    - Select a power cable suitable for temperatures in which the equipment is used.
    - Do not reuse cable seals. If re-terminated, use cable seals with unbroken membranes.
    - If the cable is removed from the strip-free unit, strip all cables again and reconnect.
- Warning!** Temperature of the heating cable at the cable entry point may exceed 70°C (158°F).

### Applicable Cable Approvals

Cable Type	Blade Reference	Bus Wire Size	Power Cable Size
FSLe	TB-2	16AWG	16AWG

### Approval

**CSA**  
 Industrial & Safe Location  
 Type Designation: 3A, 3B, 3C, 5A and 5B  
 Certificate Number: 1620566

For more information, visit [www.heat-trace.com](http://www.heat-trace.com)  
 or write to Heat Trace Limited, Helsby, Frodsham,  
 Cheshire, WA6 0DJ, England.

**Uponor Ltd.**  
 2000 Argenta Rd., Plaza 1, Ste. 200  
 Mississauga, ON L5N 1W1 CANADA  
 Tel: (888) 994-7726  
 Fax: (800) 638-9517  
 Web: [www.uponor.ca](http://www.uponor.ca)

**uponor**